



*Union
Cycliste
Internationale*

BMX TRACK GUIDE





INTRODUCTION

Introduction

1	General introduction	Page 3
2	Questionnaire for track design	Page 4
3	Elements of the track	Page 5 - 8
4	Scope of UCI certification	Page 9

Track Design

5	General track dimensions	Page 10
6	Elevation of site	Page 11
7	Key measurements	Page 12 - 13
8	Length	Page 14
9	Width	Page 15
10	Basic track layouts	Page 16 - 18
11	Start ramp	Page 19 - 23
12	Straights	Page 24 - 27
13	Turns	Page 28 - 29
14	Jumps	Page 30 - 31
15	Finish area	Page 32
16	Track markings	Page 33
17	Safety next to the track	Page 34 - 35

Construction

18	Artificial structures	Page 36
19	Construction materials	Page 37
20	Maintenance	Page 37
21	Drainage	Page 38

Venue Facilities

22	Venue setup	Page 39 - 43
----	-------------	--------------

Certification Process

23	Track certification process	Page 44 - 45
----	-----------------------------	--------------



1 General Introduction

BMX

Bicycle moto cross (BMX) started in the late 1960s in California, around the time that motocross became a popular sport in the USA. The motorized version of the sport was the inspiration for human powered competition. Children and teenagers with the desire but not the means to participate in motocross sated their appetite by racing bicycles on self-built tracks. These young adventurers completed the imitation by dressing themselves up in motocross gear. The sport was given the name 'BMX' and the conception was complete.

BMX racing offered exciting action at a low cost, close to home. It is easy to see why the sport was an instant hit. In California the sport was more popular than anywhere else. During the early 1970s a sanctioning body for BMX was founded in the U.S.A. This is considered as the official start of BMX racing. As that decade progressed, the sport was introduced on other continents too, among them Europe in 1978.

In April 1981, the International BMX Federation was founded, and the first world championships were held in 1982. BMX rapidly developed as a unique sporting entity, and after several years clearly had more in common with cycling than motorcycle racing. Thus, since January 1993 BMX has been fully integrated into the Union Cycliste Internationale. In 2008 BMX entered the Olympic Games in Beijing. With a successful edition in 2012 during the Olympic Games in London, BMX has established a solid position within the Cycling sports.

As BMX is a young sport, there is a lot of development going on. Riders and their teams are becoming very professional. To standardise the sport, it is necessary to establish guidelines for BMX track construction. This information is directed at National Federations, Organizers, companies, associations & clubs interested in receiving UCI certification for their track design.

The purpose of these guidelines is to allow track builders around the world to build coherent race tracks where certain landmarks are clearly defined in order to comply with the UCI standard. It will also assist National Federations and governing bodies to select an appropriate area and to define on which level they want to promote BMX.

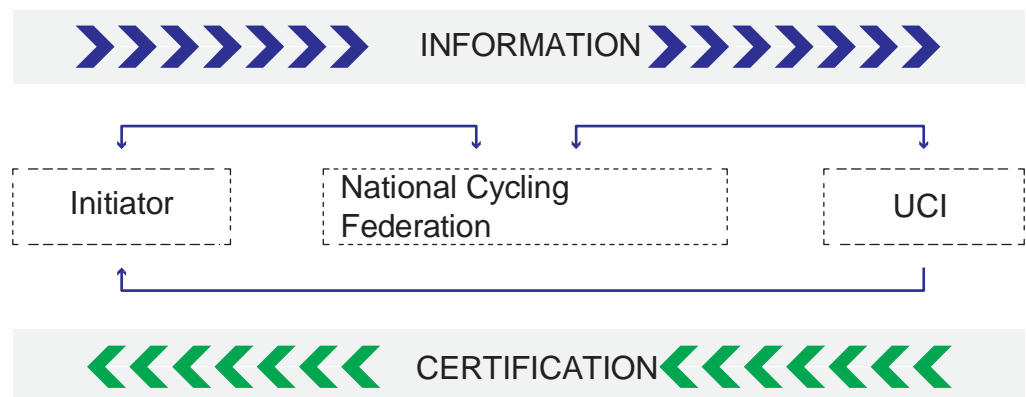



INTRODUCTION

2 Questionnaire for new track initiators

Description	The track design questionnaire addresses the basic elements of track design that an initiator will face. It helps to provide a quick overview & understanding of the intent and goals of the new track. It also establishes a process and provides the tools for addressing the National Cycling Federation
Who ?	The Initiator – that is, the person or group interested in building a track
What is the purpose ?	Youth development Professional Training Circuit Youth development and Professional Training circuit
What is the goal ?	Training Competition Training and competition
Which level races ?	Olympic Games UCI BMX World Championship UCI BMX Supercross World Cup Continental Championship Other events (C1 events, National Championships, National Competition)
Setting:	Indoor / outdoor In a sporting center / facility of the state or city/private
Facilities:	Team area Staging area Starting hill pathway Starters platform Speakers tower Commissaires platform Timing and scoring office Toilets
Financial Strategies:	National federation National Olympic Committee Club Association Sponsorship Private
Timeframe:	Project Schedule
Contact:	List of people responsible Communication channels

3 Elements of the Track

- | | | | |
|---|------------|---|-------------|
| 1 | Start Ramp | 6 | Straight 3 |
| 2 | Straight 1 | 7 | Turn 3 |
| 3 | Turn 1 | 8 | Straight 4 |
| 4 | Straight 2 | 9 | Finish Area |
| 5 | Turn 2 | | |

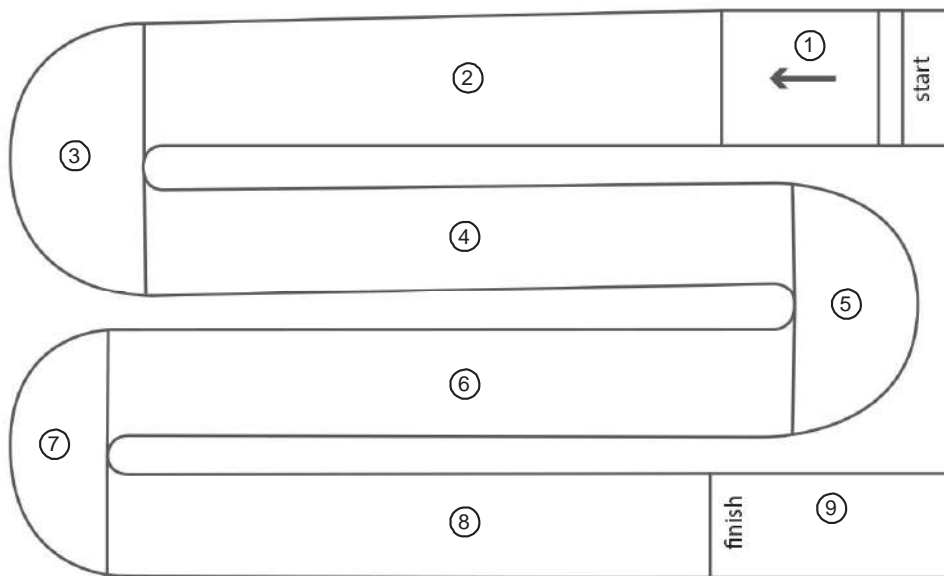

Direction: All track diagrams in this document are shown with a left-hand first turn; however, tracks can also be built the other way around

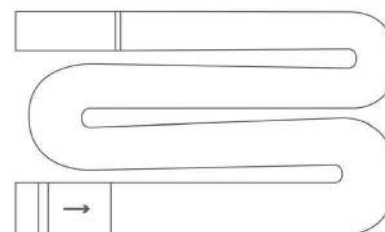
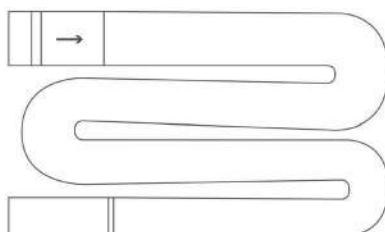

The Start Ramp



The Gate



The Straights



The Turns



The Finish Area



4 Scope of UCI Certification

Description	Scope of UCI certification
Limits	It is not within the remit of the UCI BMX Track certification process to approve / certify anything other than the track itself. However, areas immediately adjacent to the track are considered relevant for the safety of riders.
Zone of influence	The zone of influence covers the area 2.0m either side of the white track boundary lines

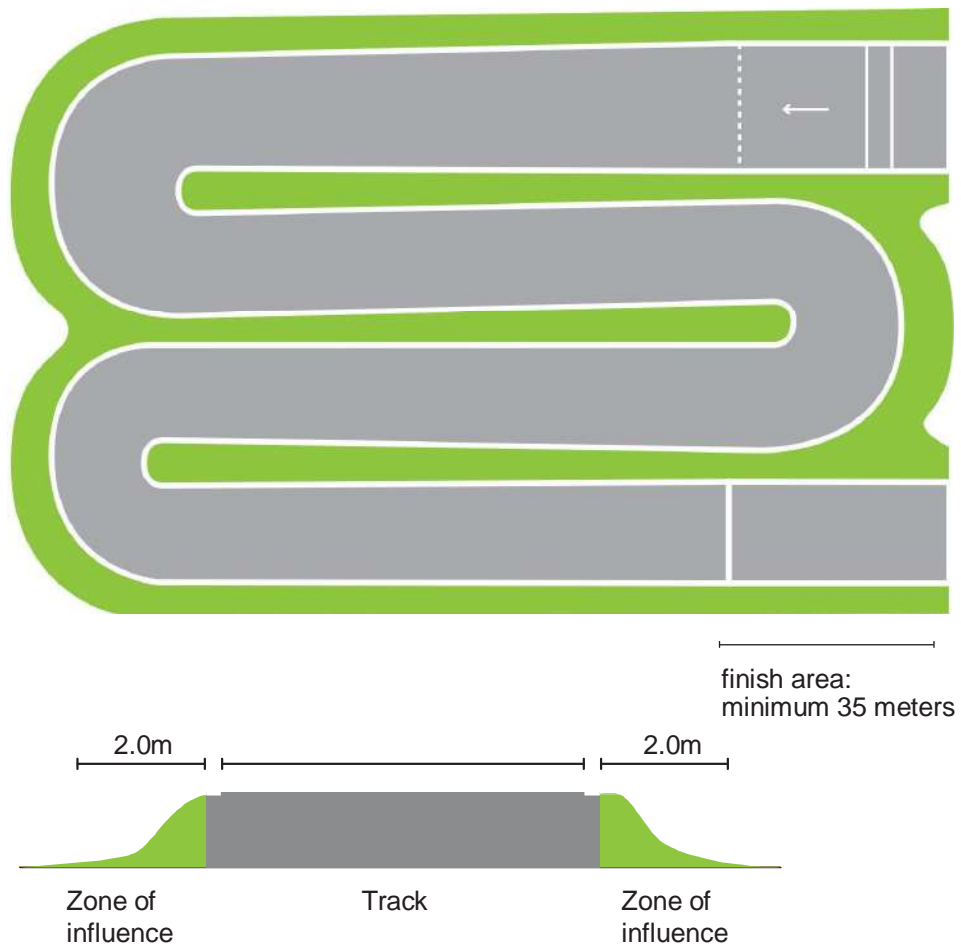

Further details regarding safety considerations are shown in chapter 17 :
"Safety Zone" page 34

5 General Track Dimensions

Description The minimum dimensions required to build a UCI certified track

Single Start Ramp

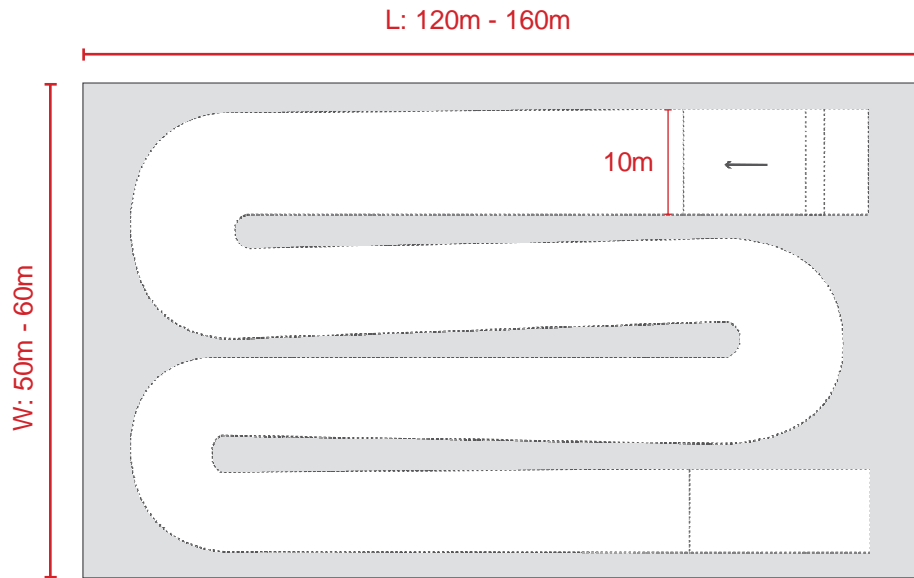

Double Start Ramp

8m Ramp on outside
5m Ramp on inside

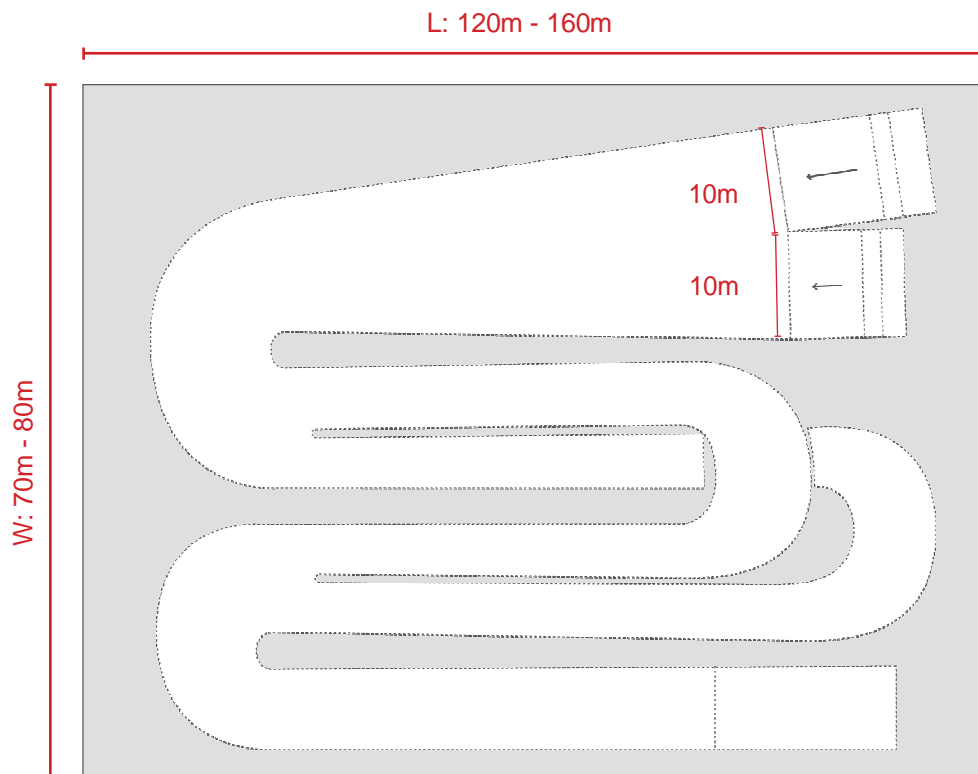

The 8m Ramp is aligned with the outer track straight, where as the inner part of the straight coming from the 5m ramp merges with the main track direction.

6 Elevation of the Terrain

Description UCI Certified BMX track grading / elevation

Requirements Any elevation change across the site of a BMX track must be favourable to the direction of the track. That is, if the track is on a slope this must either be levelled, or the track must be oriented so that the first straight is higher than the final straight of the course.

The maximum allowable height difference is 4m.

Where a height difference is included, changes to the height must be gradual across the length of the track.

Section sloped Site

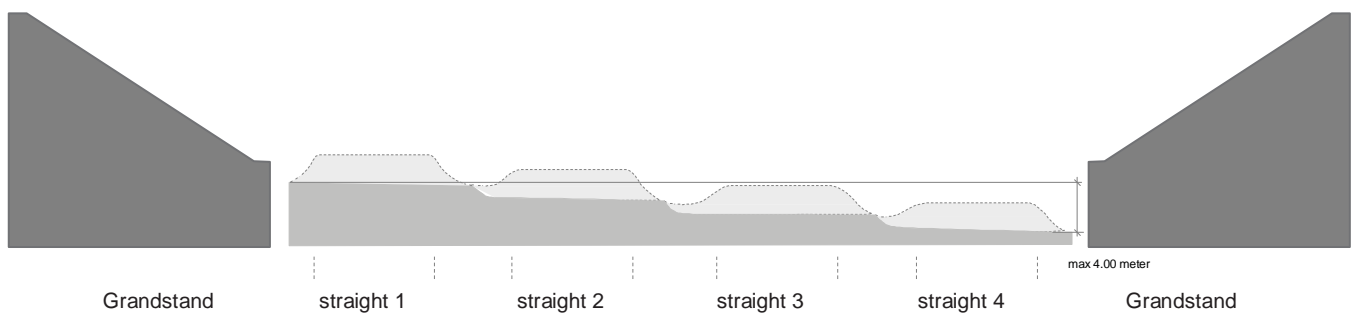

Section flat Site

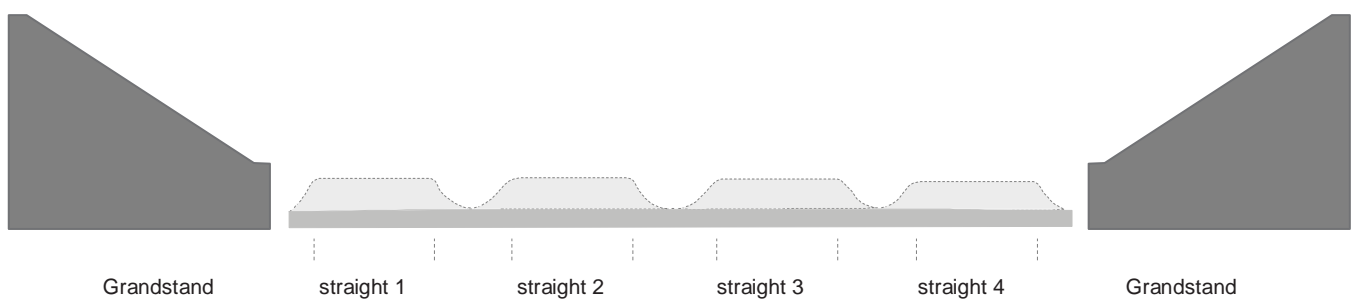

Description

UCI Certified BMX track measurement for straights and turns.

Where does a straight end? Where does a turn begin and end?

**Definition
straights & turns**

The first straight starts at the start gate and ends with the first turn.
The beginning of a turn is defined as a line at the inner side of the turn, perpendicular to the center line of the straight.



Bottom line and Inner radius

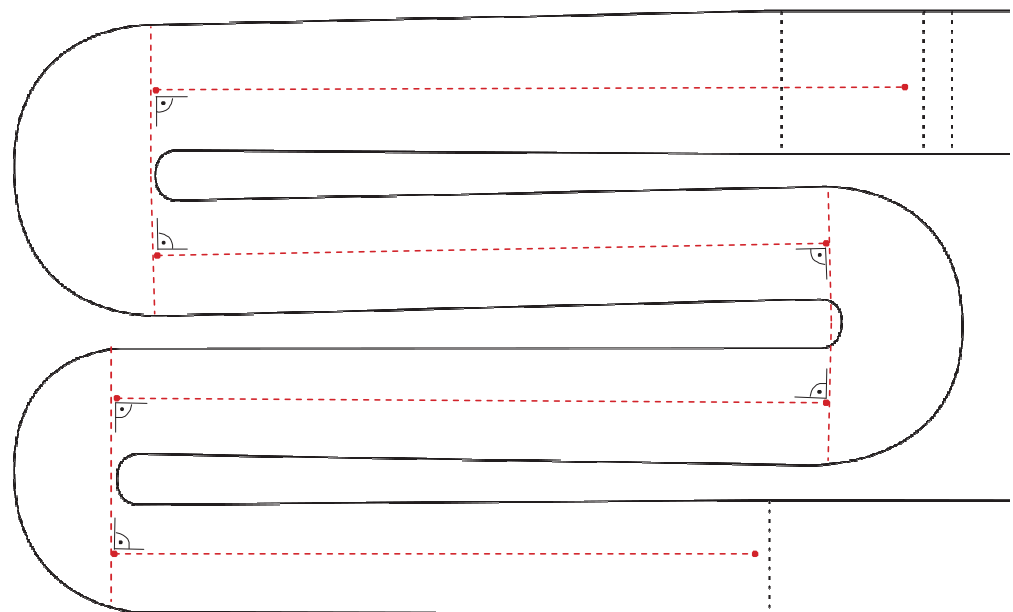

Description

UCI Certified BMX track measurements

The following sections require minimum distances in order to provide a secure setup and a good flow throughout the racing track.

- ① Bottom of Starting ramp to foot of first jump: minimum 5m
- ② The minimum distance between the exit of turn 1 and the peak of the first jump is 20m to ensure that the riders can align themselves after turn 1
- ③ The distance from the foot of the final jump to the finish line must be minimum 10m.
- ④ Finish Zone minimum 35m

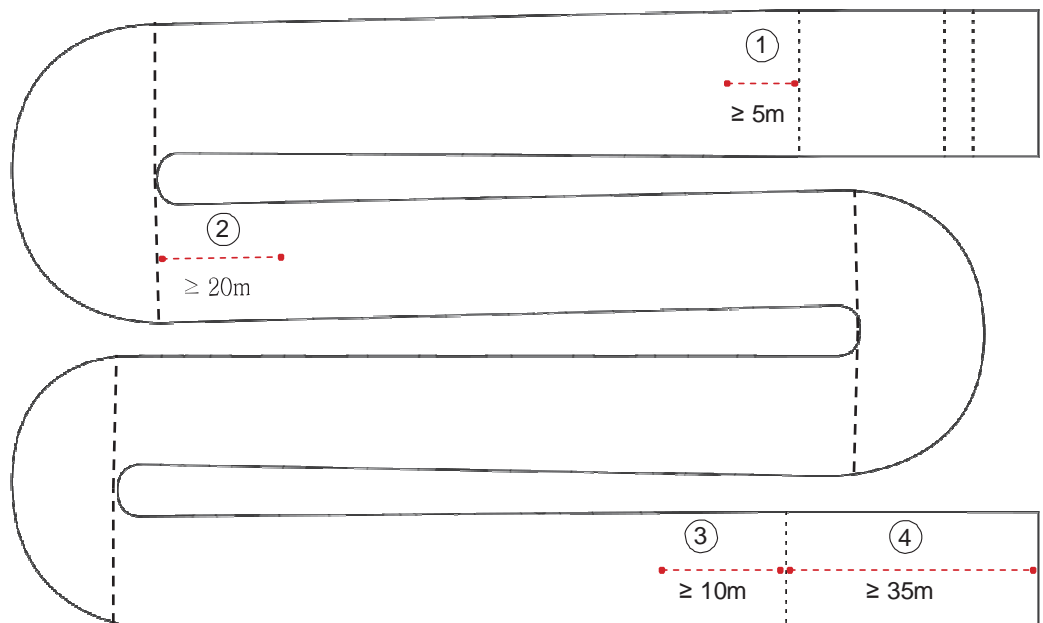

8 Length of Track

Description	Minimum and maximum dimensions allowed
Requirements	Overall length of a BMX track is required to be between 300 - 400m

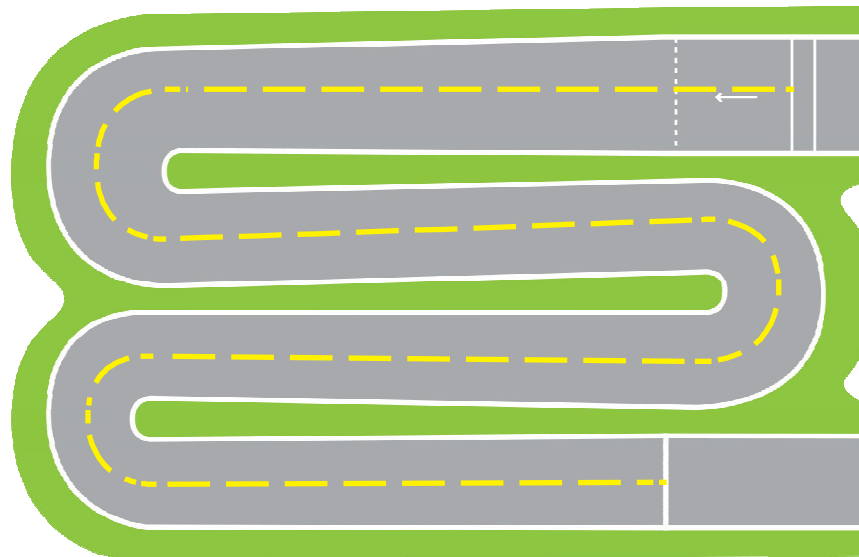

How to measure ? Measurement is taken on in the virtual center line of the track, i.e.the riding surface including dips between jumps, from the starting gate to the finish line.

An easy way to measure is using a line roller. Mark the essential middle points with tape or marking spray paint and then walk the center line.

Do not take the measurements from the drawing/plan as the hills and jumps will add a couple of extra meters.

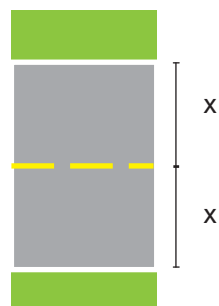

9 Width of Track

Track Width

The track design must respect the width of UCI certified BMX track

The start ramp must be 10m wide. For details see section start ramp, page 19 - 23.
The first straight must be 8 - 10m wide.

The remainder of the track must maintain a minimum width of 6m.

All measurements of track width are taken from the insides of the white boundary lines.

First straight:

10 meters which, may gradually change to a minimum of 8 meters, which must be maintained through the entire first corner before any further narrowing

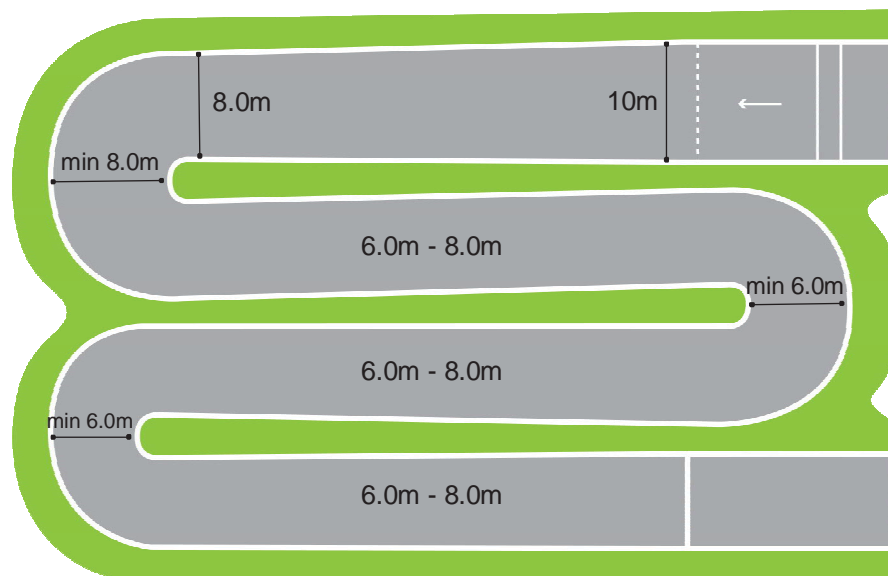

Measuring method

Safety Zone = min. 2.00 m
measured outside white marking

Track width: measurement between
the inside edges of white boundary
lines

Safety Zone = min. 2.00 m
measured outside white marking





Layout

The layout of a UCI Certified BMX track must conform to one of the layouts illustrated in this section. The layout may be altered only to allow for a left or right handed first turn.

Crossing the male and the female courses anywhere other than berm jump in turn 2 is not allowed. 'S'-shaped sections of the track are not allowed.

Basic Track Layout

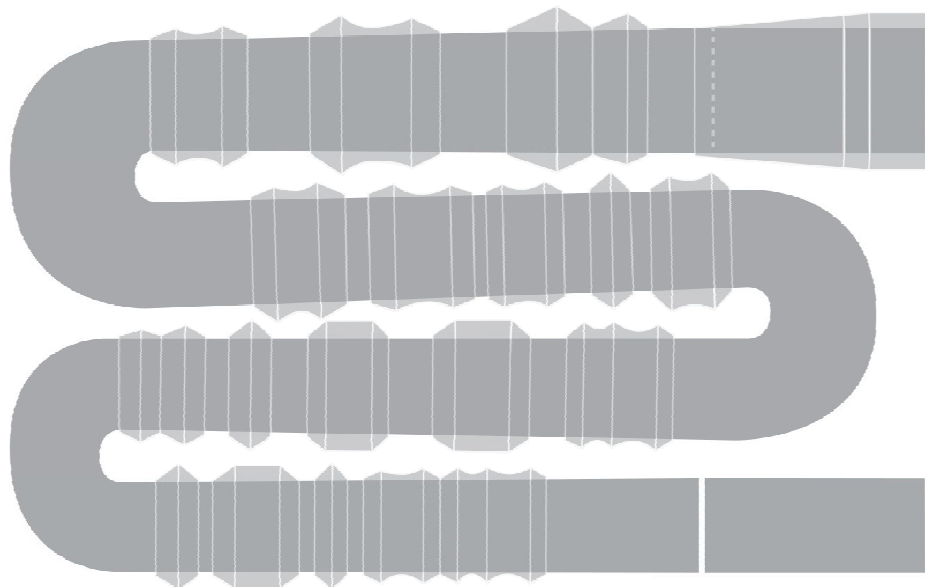

Split 2nd Straight

Shared 1st, 3rd, 4th straight and split 2nd straight

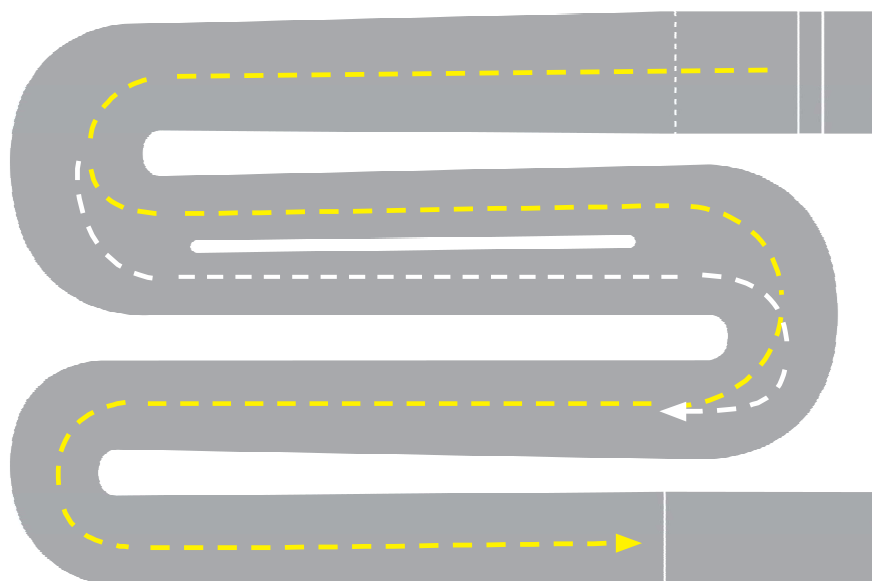

regular track



pro section



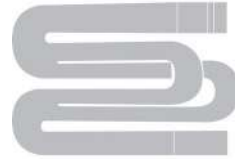

Split 2nd and 3rd Straights

Shared 1st and 4th straight - split 2nd and 3rd straight

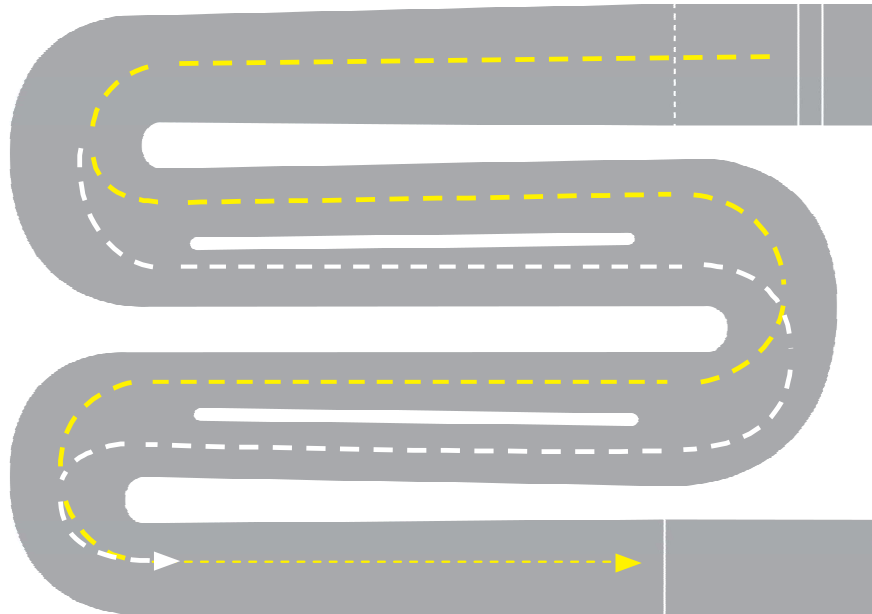

Split 3rd Straight

Shared 1st, 2nd, and 4th straight, split 3rd straight

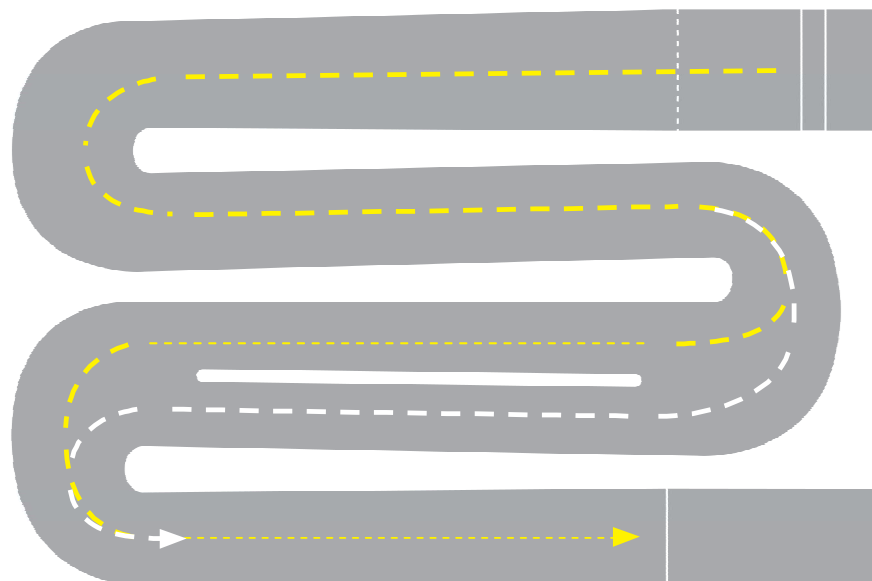

regular track



pro section



**Berm Jump in
Turn 2**

For higher level competitions track designers can introduce a berm jump in turn 2 which will add a significant obstacle for advanced male riders.

This feature extends the track for these riders by jumping over the track in turn 2 leading back to a shared turn 3.

regular track



pro section

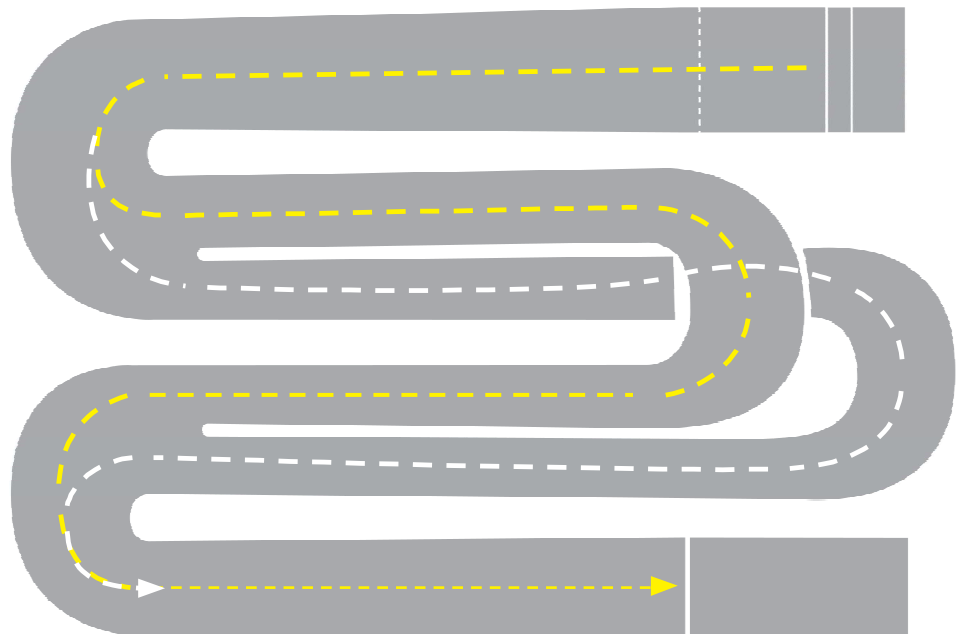

Berm jump

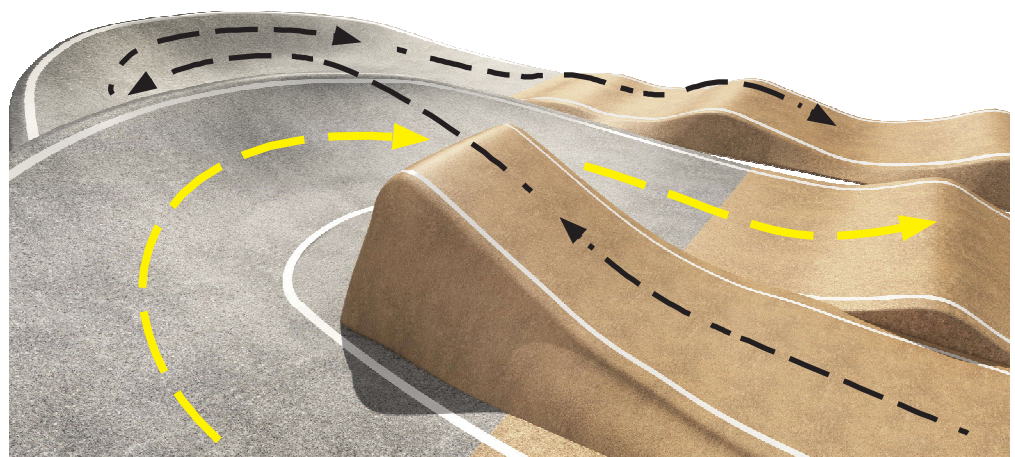

11 Start Ramp

Description UCI Certified BMX start ramp

Requirements Start ramps must adhere to the geometry provided for 8m and 5m ramps.

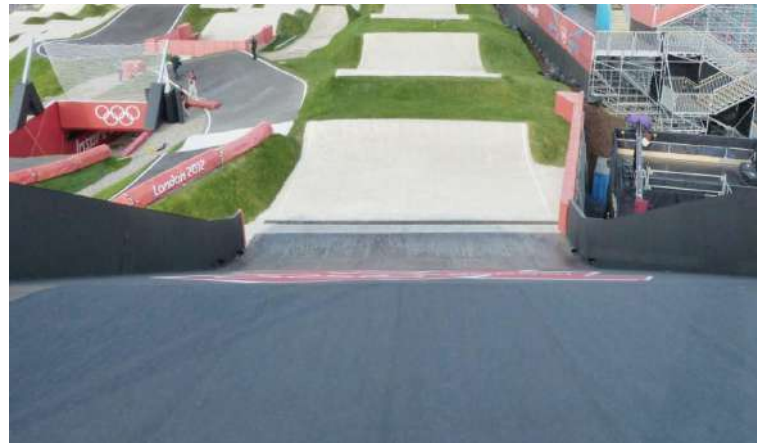

Geometries There are three sizes of ramps that differ in heights:

8m : Olympic Games BMX
UCI BMX World Championships
UCI BMX Supercross World Cup
Continental Championships

5m : UCI BMX World Challenge

2,5m - 5m: These ramps can be used for C1 events, National Championships and National Competitions and don't need a UCI BMX track certificate to organize events.

Surface The surface material of the starting ramps should not be slippery and allow for good traction in all weather conditions. Recommended 'R' value =13; can be achieved with outdoor platform plywood with anti-slip paint. Likewise, any logos printed on the ramp must be anti-slip.

Safety The sides of the starting ramp must be of closed construction with padded surfaces. A high-capacity drainage channel (covered) must be found at the bottom of the ramp, across the width of the track in the transition between the ramp and the track surface.

Access Access to the ramp can be provided through a sloped path (preferred solution) or a staircase at the back or either side of the starting ramp.

If a sloped path is not possible, the stairs must be 2m wide with a gutter to roll the bikes up to the platform. Stairs must have landings at reasonable intervals (to allow for rest). If there is enough space, the back of the hill can be lodged in the earth, allowing grade-level access, or access via a gentle slope.

8m Ramp

Important: Do not use these diagrams for construction. Upon request, the UCI can provide detailed CAD drawings meant to guide planning and construction.

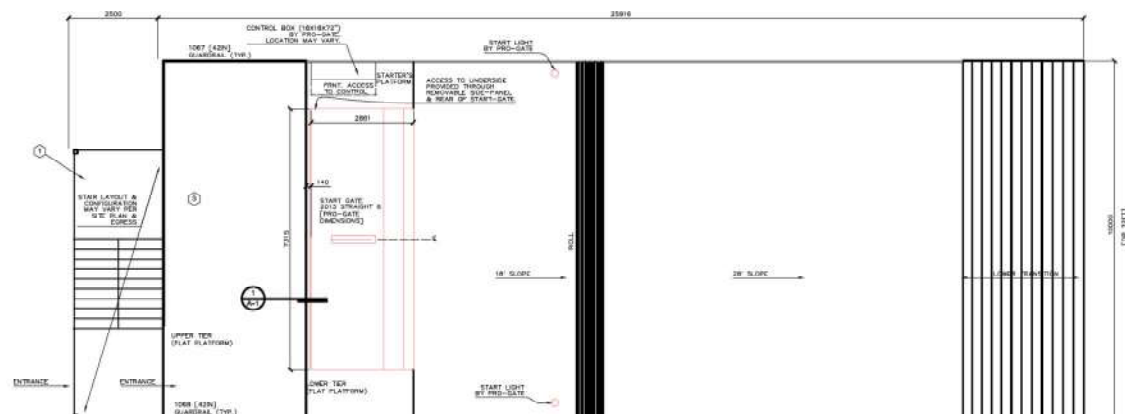
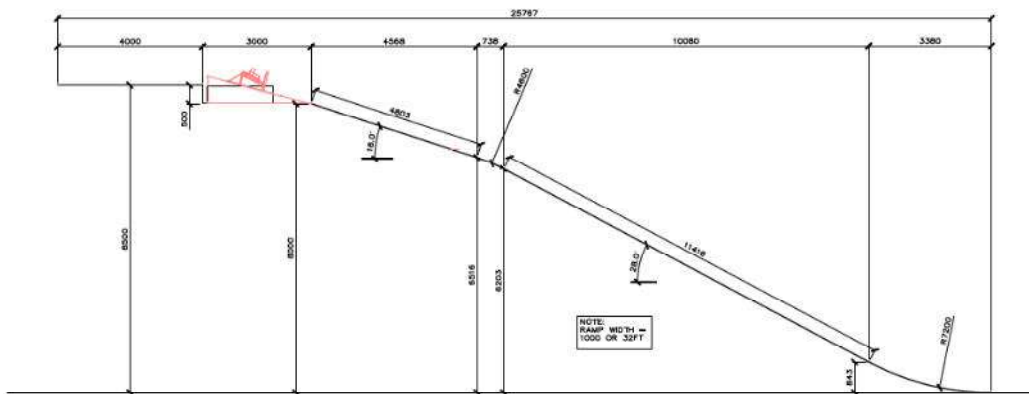
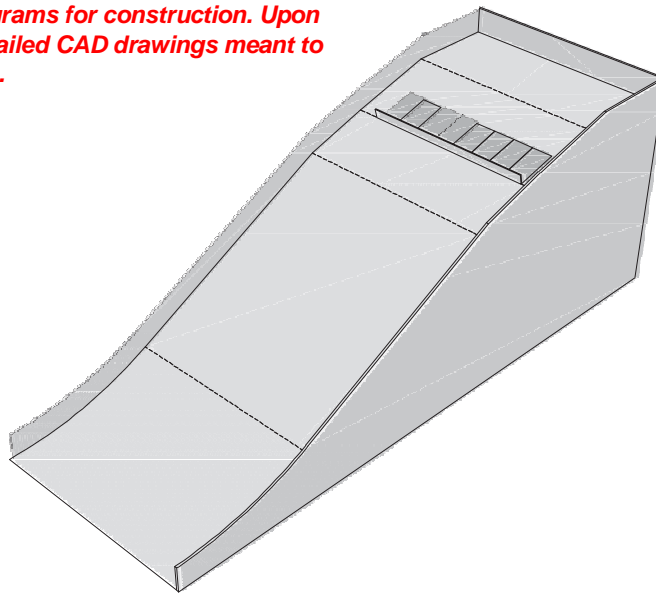

5m Ramp

Important: Do not use these diagrams for construction. Upon request, the UCI can provide detailed CAD drawings meant to guide planning and construction.

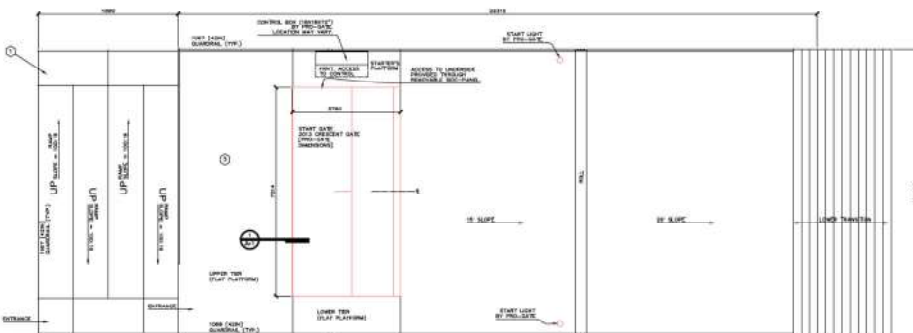
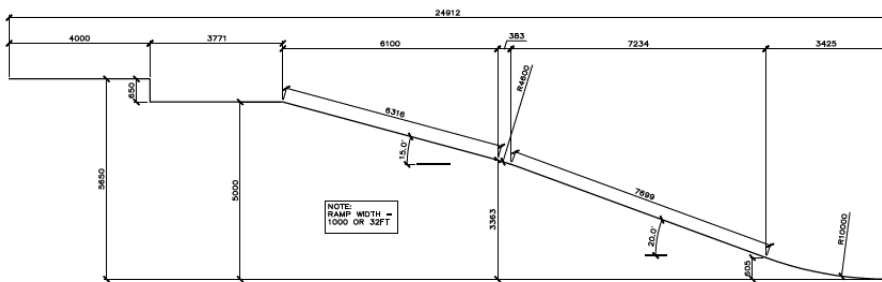
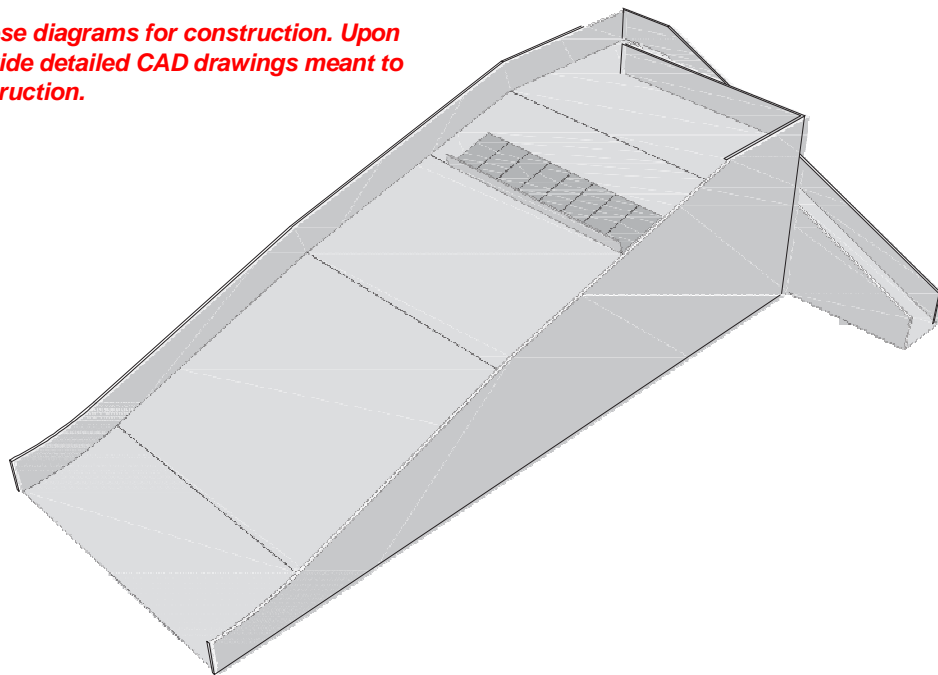

access by sloped path

Double Ramp Option

Track with both 8m and 5m ramps.

The angle between the two ramps should be as small as possible in order to minimize the effect for the riders position; the maximum such angle allowed for UCI certified ramps is 5°.

The first straight of the 5m ramp needs to be adjusted to the straight leading from the 8m ramp. The 8m ramp is preferably on the outside of the track, with the 5m ramp on the inside in race direction.

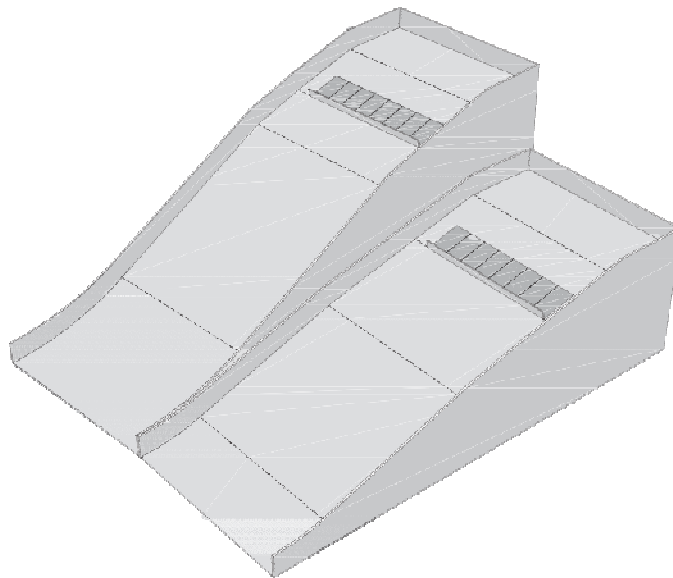

The bottom of the 5m and 8m are preferably aligned though this is not mandatory.

Description

BMX Start Gate



**Start Gate
R-B 6.1.029
Also, appendix 3 of
the BMX rulebook**

The start gate shall be a minimum of 7.3 metres in width for BMX events on the UCI BMX calendar. The gate shall have a height of at least 50 cm, with an angle no greater than 90 degrees with the slope of the ramp which supports the bicycles' wheels when they are in their starting position. Starting positions 1 through 8 must be clearly marked on the gate; lane 1 is the lane on the side of the track corresponding to the inside of the first corner.

The electronically controlled gate, to be used at all BMX events on the UCI BMX calendar, must be outfitted with a system of appropriately coloured starting lights located so as to be clearly visible from all starting lanes without disadvantage to any rider who is in the "riders ready" position. In case of a failure of the gate release system, the gate shall fall to the dropped position.

A "voice box" system is mandatory at all UCI sanctioned events described in appendix 3 of the BMX rulebook. Whenever a timing scoring system is utilised, the timing system must be activated, whereupon the time starts running, at the moment the gate-start mechanism is activated causing the gate to drop.



Description

Characteristics and design elements of the straights

First straight

It is important that the first straight provides an equal opportunity for all riders, no matter what their starting position. To do so, it should be of constant width. The start gate must be aligned with the entrance of the first turn.

The first straight includes the most difficult jumps on the track, these jumps must be achievable for both male and female riders, and include flattened safety landing areas. For World Championships when 2 start ramps are in place, the entry to the first turn should be widened and the 8m start ramp is aligned with the “pro” side of the first straight.



Straight 1 London track

Key Points

- Minimum Distance from foot of the ramp until 1st jump: 5m
- Maximum 2 jumps when first straight is shorter than 70m
- Maximum 3 jumps when first straight is longer than 70m



Straight 1 typical section

Second straight

The second straight can be split so that there are separate sections for men and women (or challenge category) riders; these can either join back together before the second corner, or can continue into a separate corner for each gender (using a berm-jump).

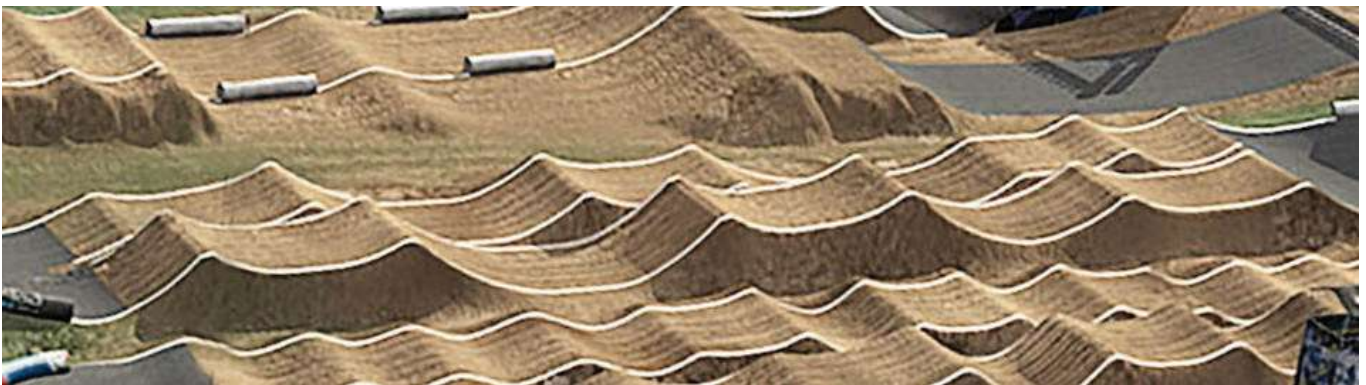

straight 2 rendering

The minimum distance between the exit of turn 1 and the peak of the first jump on straight 2, is 20m to ensure that the riders can align themselves with the correct side of the 2nd straight after exiting turn one.

- Jumps on the 2nd straight can be big and technical to accommodate with the high speed of the riders as they come out of the first turn.
- For male Championship categories it can feature a combination of big jumps that follow each other until the 2nd turn.
- For female Championships and Challenge categories it can have a combination of medium jumps which are also rideable without jumping.



Straight 2 typical section

Third straight

The 3rd straight should be the most technical part of the track, where different combinations of jumps follow each other and where different techniques can be used (jump, manual, rollers,...) There is less pedaling, but the level of technical challenge is higher.



Straight 3 London 2012 olympic track (UK)



Straight 3 typical section

Fourth straight

The 4th straight combines pedalling with other technical skills

- Less difficult jumps and rollers presenting different technical challenges
- The distance from the foot of the final jump to the finish line should be 10m.
- After the finish line there must be a minimum of 35m of run-off space for the riders, with no interruption or obstacles. This area must be the same width as the track for its entire length.



Straight 4 London 2012 olympic track (UK)



Straight 4 typical section

Design

Description of the geometry, construction and materials used.
Turns are the most difficult objects to design well.

Materials

Turns always need to be of solid surface materials: concrete, tarmac or bricks

Key Measurements

Turn 1 must be minimum 8m wide measured at the mid-point of the turn between the upper and lower white boundary markings.

The other turns must be a minimum of 6m wide, measured in the same way.



Turn 2 Dessel track (BEL)



Turn 2 London 2012 Olympic track (UK)

Geometry



turn 3 London track

Sections of a turn

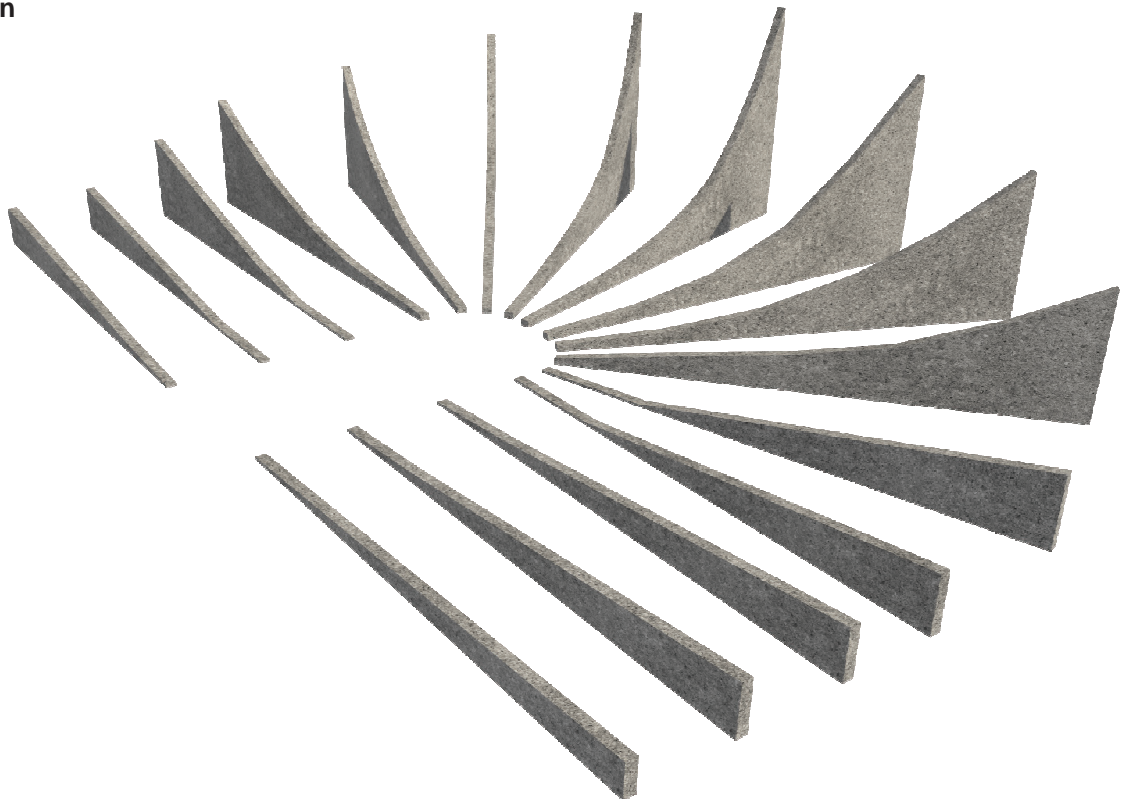

Description UCI Certified BMX track Jump design



Requirements

It is not our intention to define the dimensions and nature of jumps in a BMX track. However, it is essential that their application is in line with the above description. It is a priority that all jumps are built to a design that is rideable for the target riders, and that they are as safe as possible for all participants (see the illustrations below).

Take Off

Take off at angles of approximately 40 degrees

Safety

Safety landing for all jumps that are longer than 8m

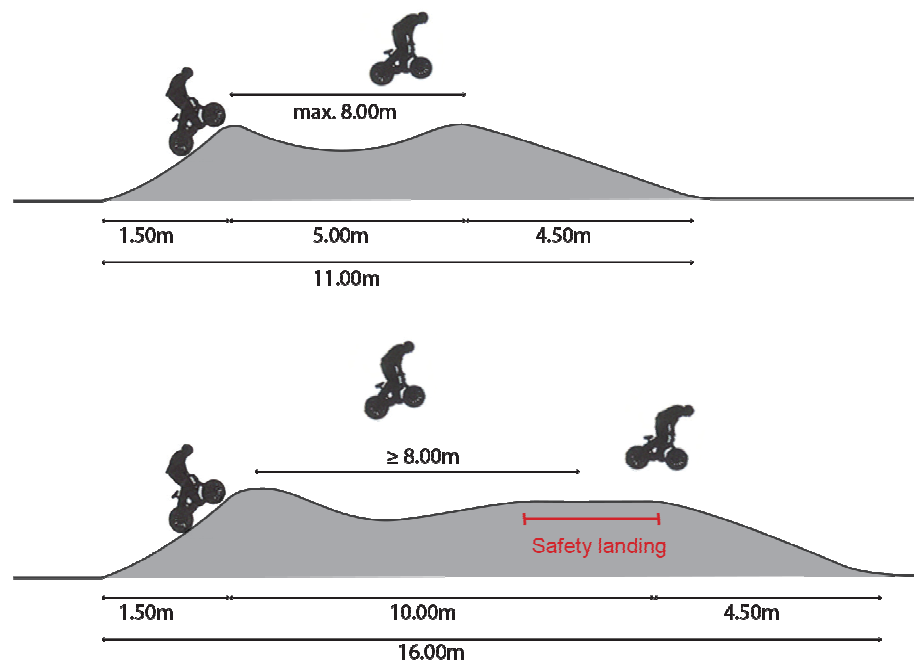

14 Types of Jumps

Description UCI Certified BMX track jump design

Requirements It is a priority that all jumps are built to a design that is rideable for the target riders, and that they are as safe as possible for all participants (see the illustrations below).

Double



Two hills spaced just far enough apart to make jumping the fastest way to get across

Step Up



A short hill followed immediately by a taller hill. Jump up to jump out.

Step Down



A tall hill followed immediately by a smaller hill. Push down to accelerate

Roller



A small hill. Can be single or combined in groups

Rhythm Section



A combination of hill and jumps where the rhythm and flow are important to find the fastest way

Table top



A jump with a flat top as a safety measure. Good for learning how to approach large jumps.

Description

UCI Certified BMX track finish area

**Finish line:
BMX rulebook 6.1.035**

The track must have a clearly marked finish line to indicate the point at which competitors will be scored, as per article 1.2.099 of the general rulebook.

All finish line commissaires shall operate from an area immediately adjacent to the finish line, which permits them a clear and unobstructed view of the riders as they cross the finish line.



Materials

Flat surface or slightly uphill, preferably tarmac or concrete but also bricks or resin bonded gravel can be used.

Safety

Any banners extending across the track above the finish line or elsewhere along the track must be at an elevation sufficiently above track level to avoid interference with the riders crossing beneath them.

Any part of the legs or any supports of the finish arch located inside the 2m safety zone must be padded.

Description

UCI Certified BMX track markings

Track markings

The white track marking lines are recommended to have a width of 8cm -12cm. Track markings must be slip resistant in all weather conditions (in particular, paint on tarmac can be very slippery). The outside and inside boundaries of all sections of the track must be marked.



Marking a split section



Description

UCI certified track safety zone

Requirements

Adjacent to the track there must be no posts / pillars / obstacles within 2m of the edge of the track that present a risk to the riders. Where these are unavoidable the track operator must demonstrate that sufficient precautions (example: padding) are in place. Likewise, as riders are more likely to leave the track in the last half of each corner, it is strongly recommended that these areas be kept clear of hazards, even beyond 2m from the outside track boundary.

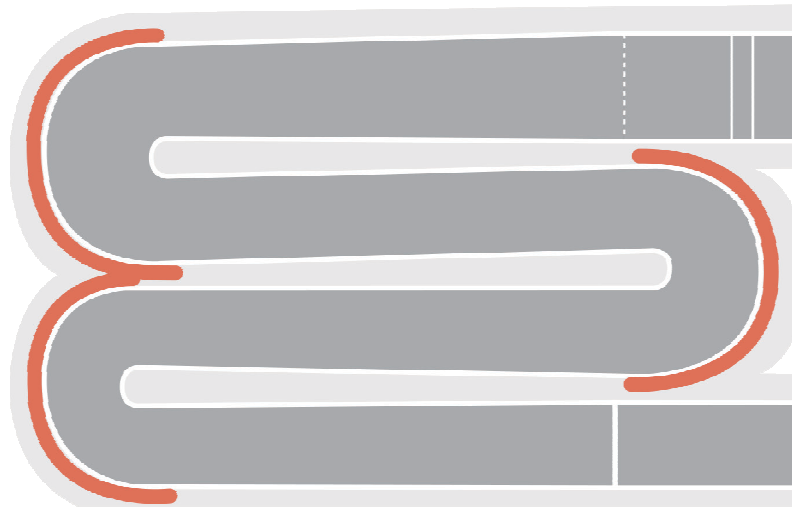

Proper Examples



Padded poles



Lighting poles or other hazards that a rider could hit should they be ejected from the track must be padded or removed

Falls / Drops



Significant falls & drops at the backside of turns need to be made safe (for example, fenced off and/or padded to prevent riders or others (photographers, commissaires) from falling.

Suggested minimum height of fence 1.1m if drop is less the 1.50 m.

If drop is heigher than 1.50m the fence must be 2.0m

Equipment / Tools



Equipment / working tools are often found in track areas as they may be necessary for filming or maintenance or other special occasions.

They need to be removed from the safety zone.

Requirements

Artificial structures are not permitted on a UCI certified track. Such structures can include (but are not limited to):

- portable jumps
- box jumps
- tunnels
- bridges

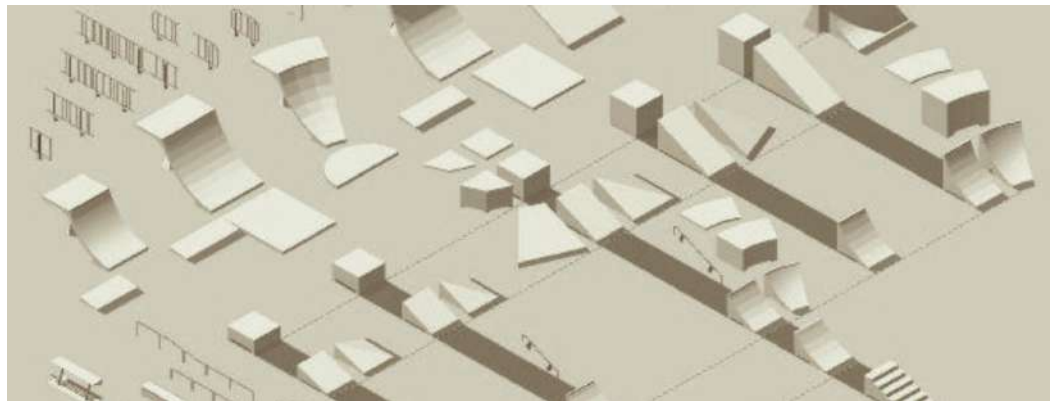

**Wooden ramp in
zone of influence**

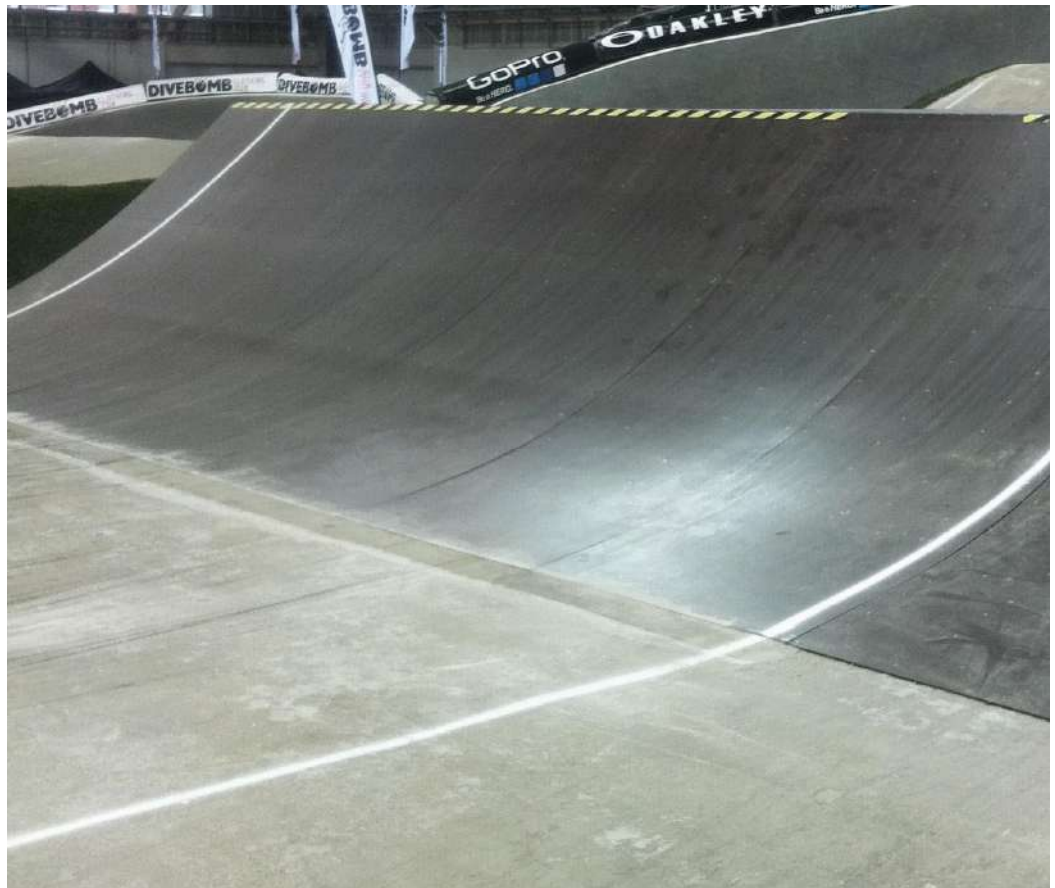



19 Construction Materials

Description	For BMX tracks built in a wet climate (such as Europe), a variety of materials set down in layers are recommended in order to give a hard-wearing, all weather surface that is rideable in wet weather as well as dry weather.
Straights	<ol style="list-style-type: none"> 1) Base material: This should be built in 300mm layers. Clay based, dry, non-organic material, good compaction levels. 2) Sub-base material: Laid to the depth of 100-150mm - type 1 stone 25-40mm in size, scalplings, crushed concrete, stone based which compacts well to give a sealed surface. 3) Surface material: A limestone or granite crushed stone surface. This is laid to the depth of 100mm. Material size can range from 10mm to dust or 6mm to dust. In drier climates, a 4mm to dust size can be used. Generally the larger the size the better it handles wet weather. The top layer should compact to a sealed hard surface. Water may be required to get it to the desired finish.
Berms	<ol style="list-style-type: none"> 1) Base material, as above. 2) Sub-base material, as above, although a larger sized aggregate can be used. 3) Tarmac in 2 layers. A 32mm sized binding course (laid to the depth of 75mm) which is then covered by a second layer of 6mm wearing course tarmac (laid to the depth of 50mm). The surface layer should be well sealed so that the stones within the tarmac are unlikely to come loose as the surface wears.
Edges	<p>Edges of the track and back and sides of jumps and berms.</p> <ol style="list-style-type: none"> 1) These areas are typically covered in top soil and grass seeded. All edges should be smooth. No sharp or unsightly edges. Typically soil is laid from 100-150mm in depth. These areas are then typically grass seeded, or turf is applied.

20 Maintenance

Description	Maintenance of the track should be considered starting from the design phase. A maintenance plan should be included in any bidding process for builders.
Proposed Schedule	Regular maintenance depends on the local weather conditions, building quality and the frequency of use. It is recommended to have an inspection by the track builder every year to assess the necessary interventions.

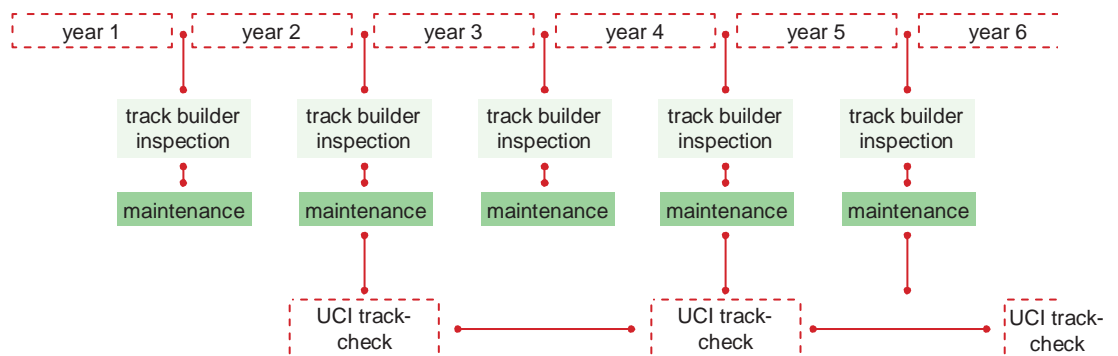

Inspections by UCI UCI's certified tracks will be checked regularly (during recertification, every 2 years).

Description

BMX Track drainage summary

Requirements

Any UCI certified track needs to have a drainage suitable for the climate where it is located. The needs of a track in a wet climate such as England can vary considerably from a track in very dry area like southern California. All track surfaces should be slightly crowned (graded) so that surface water can flow to either side (instead of pooling on the track) and can be handled by the drainage system along the sides of the track's straights and turns.

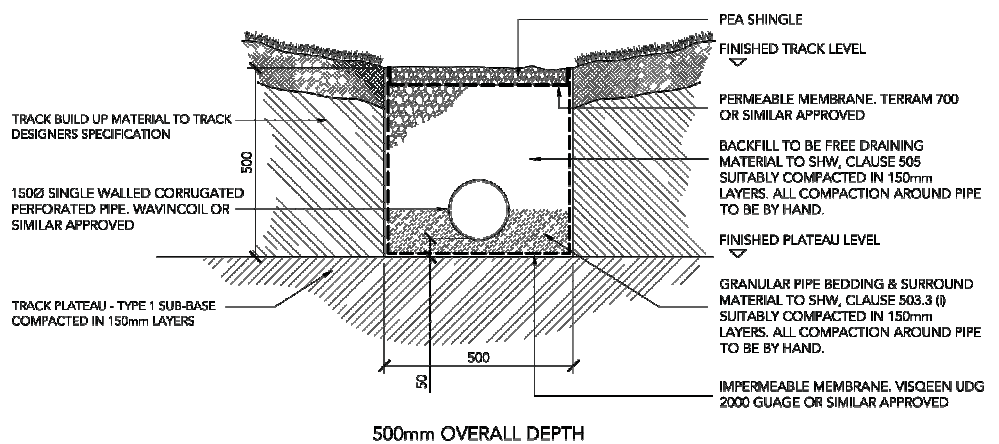
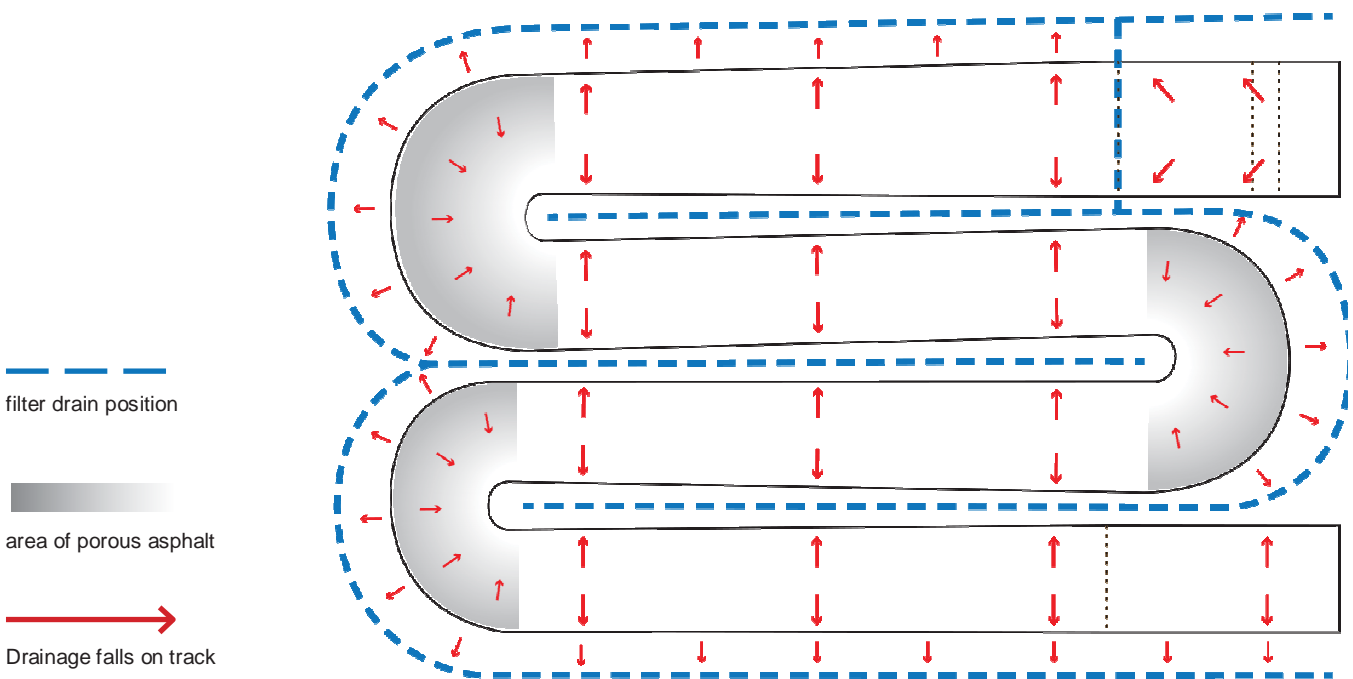

Description

The facilities below describe the potential infrastructure that is needed to organize BMX competitions. The numbers identify the locations of these areas on the map which follows.

Team area (4)

A fenced team area must be provided for teams. Each team should have an area of minimum 3 by 6 meters. The team area is the place at the track where bikes shall be stored and riders can prepare themselves for the race.



Outdoor team area with tents



Indoor team area with barriers

Pre staging area (1)

Pre-staging and staging area

Pre-staging area (1) – Depending on the number of riders participating, a pre-staging area should be provided. This is an area where riders are called in groups in the order in which they will race. This area shall be equipped with a PA system and enough fencing to create a well functioning area. Additionally, signs can be used to indicate the age group that needs to present itself in the pre-staging area.

Staging area (2)

Staging area (2) –The final staging area before the start. It shall be preferably covered and have ten staging lanes numbered 1 to 10, where riders shall assemble in accordance with the instructions given by the staging officials. The lanes must be 1m wide and 15m long. For large events, it is also optional (but recommended) to provide a double staging area with 2 times 10 lanes. Ideally, this should be close to the back of the start hill.



Pre-staging



Staging area

Starting hill pathway (3)

If a pathway is not possible, then stairs of minimum 1,5m width are advised, with a gutter to roll the bike up the starting hill. The gutter should be some distance from the railing so that the handlebars don't hit the railing posts.

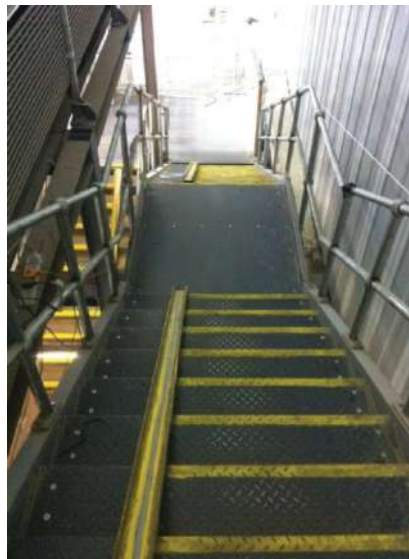

Stairs with gutter for bikes



Pathway

Starters platform (5)

A platform can be provided for the starter. It is important that the starter has a good view of the track, the gate and the riders.

The platform can be covered to provide shelter.



Announcer tower (6)

A viewing tower can be provided for the announcers. This should be placed in an area that provides a good overall view of the track, while blocking the view of the spectators to the least extent possible. Ideally, it is covered to protect the announcers from all weather conditions.



Announcer tower

Commissaires platform (7)

The commissaires platform can be a platform of 1,5m by 1,5m that is extended from the top of a turn, or can be built into the top of the back-side of the corners from the soil used to build the corner. This enables the commissaire to stand on a horizontal platform and which gives the commissaire a good view of the track and easy access to go down into the infield.

Medical room (8)

A medical room must be provided during BMX competitions. The size depends on the size of the event. It is recommended to have a room for treatment of patients and a recovery room to keep riders in observation if necessary.

Timing & scoring office (9)

A working space for timing next to or close to the finish area and with a clear view of the finish line. A minimum of 2 x 8 meters space is required, and should include a working space and high-speed photo-copier / printer for the secretary commissaire.



Working spaces



Working spaces

Toilets (10)

Toilets must be provided near the team area, and also the staging area for riders, and in the spectator zones. The following table provides guidelines about the number of toilets needed for events.

ATTENDANCE	EVENT DURATION IN HOURS						
	1	2	3	4	5	6	7
250	2	2	2	2	2	3	3
500	2	3	3	4	4	4	4
1000	3	4	5	6	6	7	7
2000	5	8	10	11	12	13	13
5000	12	20	24	27	29	31	32
8000	20	32	38	44	48	49	50
10000	24	39	47	54	58	62	64
20000	48	77	95	107	115	120	127

No. of toilets depending on spectator numbers

Grandstands (11)

The grandstands are best placed along the straights to create an arena feeling. The following grandstand capacity is recommended for races on the UCI calendar:

International Competition Class 1	C1	3000 spectators
Continental Championships	CC	5000 spectators
UCI BMX Supercross World Cup event	CDM	3000 spectators
UCI BMX World Championships	CM	7000 spectators
Olympic Games	OG	7500 spectators



TRACK FEATURES

22 TRACK FEATURES

- 1 Pre staging area
- 2 Staging Area
- 3 Starting hill pathway
- 4 Team area
- 5 Starters platform
- 6 Announcer tower
- 7 Commissaires platform
- 8 Medical room
- 9 Timing & scoring office
- 10 Toilets
- 11 Grandstand

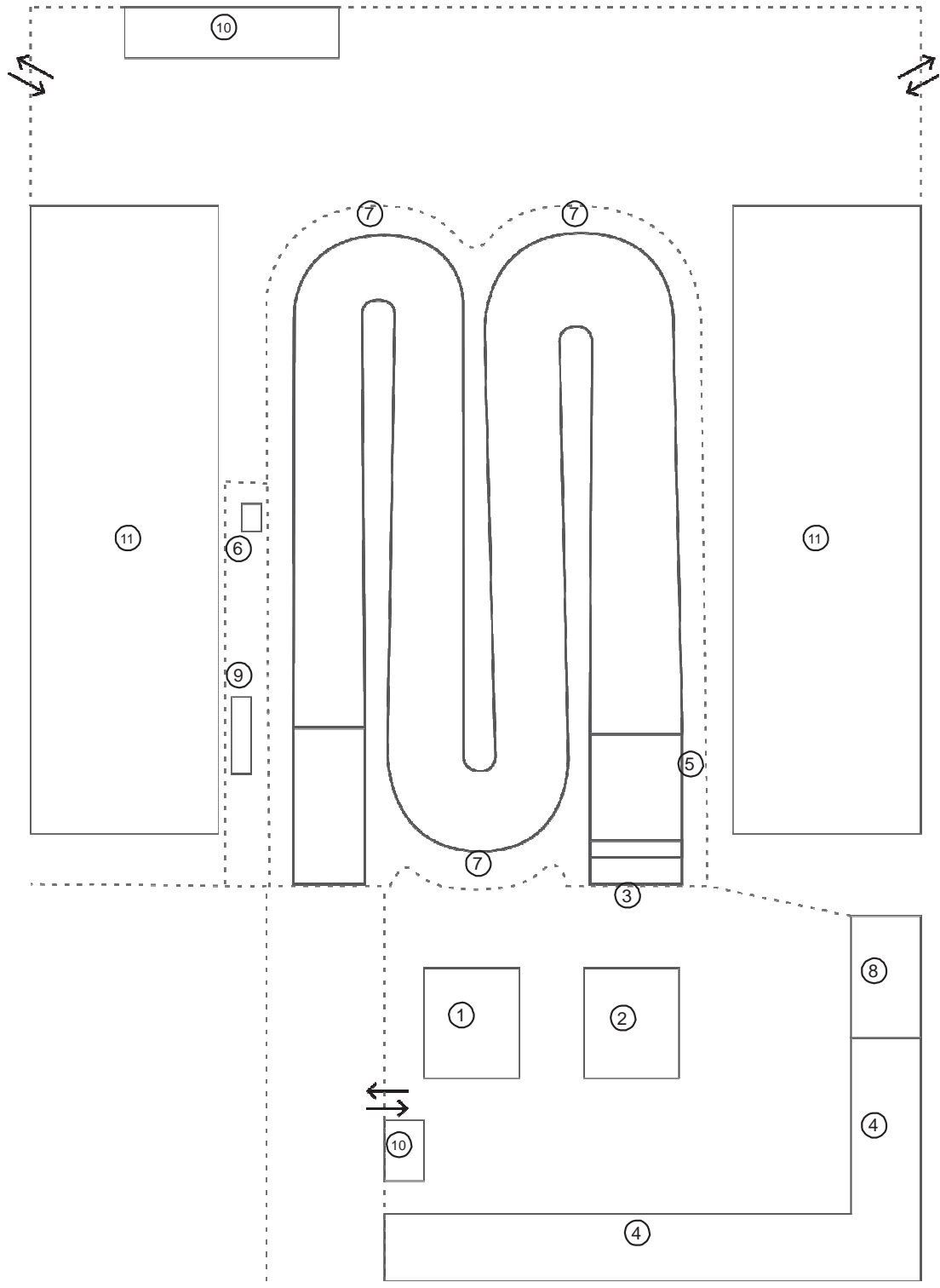



The UCI BMX Track certificate is a quality label for BMX tracks and means that the track meets the UCI requirements established in the UCI BMX Regulations. Any track may apply for a UCI Track Certificate.

However, the UCI Track Certificate does not constitute an official certification of the quality of the infrastructure and of the security on and around the track (indeed the track certificate holder is required to abide by all local laws and regulations concerning security). Likewise, the UCI is not liable under any circumstances for any damages related to the use of the track (as per articles 6.7.016 to 6.7.018 of the UCI Regulations).

An UCI BMX Track Certificate is valid for 2 years, ending on 31 December. The validation of the UCI BMX Track Certificate will be done by a UCI appointed track inspector according to the process outlined in the UCI Regulations.

The application process for a UCI BMX Track Certificate varies depending upon the level of event being sought by the organization responsible for the track.

For the Organizing Committees of Continental Championships (beginning with Continental Championships organized in the 2016 season) or tracks that have the desire to bid for a future major event (or indeed for any track for which a track certificate is desired), the process and application form for "Other Events" will be used.

For UCI BMX Supercross World Cup events, the Track Certification process is an integral part of the event bid, and is taken care of within that context. *Important! If you anticipate bidding for a UCI BMX Supercross World Cup to be held in the 2016 or later, please contact the UCI as soon as possible concerning the track certification process.*

For UCI BMX World Championship / Challenge events, the certification process to be followed is described within the event contract once the UCI Management Committee has chosen the successful bid. In many cases, the track for a BMX World Championship may not yet exist at the time that a bid is accepted.

For the Olympic Games, the UCI works with the Local Organizing Committee to ensure that the track is constructed within the allowable parameters and is certified prior to the Games.

What is the Track Certification Procedure?

The exact process used will depend upon the reason for the track certificate application as explained in the previous section; however, all successful UCI BMX Track Certificate applications include an inspection of the track in question.

In general, once an application is received, the UCI will schedule a track inspection by a UCI track inspector at a mutually agreeable date. Following the inspection, the track inspector will make a report to the UCI; the UCI will then decide whether the track certificate can be issued or not based upon the report of the track inspector, and the applicable UCI regulations.

In case the application for a track certificate is not successful, the UCI will provide the reasons why a certificate was not issued.

How Much Does Certification Cost?

For class 1 countries, the fee is € 1'500. For class 2 countries, the fee is € 900. The classification of any particular country is defined within the UCI Financial Obligations, which can be found here:

http://www.uci.ch/mm/Document/News/NewsGeneral/16/55/24/OF14_BMX_E_English.PDF



**Union
Cycliste
Internationale**



BMX TRACK CERTIFICATION

23

Track Certification Process

If the UCI decides that the track is eligible to be inspected, the UCI will send a first invoice for ½ of the total amount (i.e. € 750, or € 450, respectively). The track inspection date will not be confirmed until this invoice is paid. If the inspection is successful, an invoice for the remaining half will be sent. The UCI Track Certificate will not itself be granted or come into effect until the second invoice is paid in full.

The UCI will pay for the travel costs and daily allowance of the track inspector; the organization applying for the track certificate must cover the hotel costs, meals and local transportation of the track inspect, as well as providing any measuring equipment needed by the track inspector.

How do I Apply?

To receive the correct application form or to ask any questions, please contact Mr. Kevin MacCuish, UCI BMX Coordinator, via e-mail or telephone:

kevin.maccuish@uci.ch

Tel. +41 24 468 58 11

Applications for the UCI BMX Track Certificate must generally be received each year by March 31st with validity beginning for the next year. However, certificate applications for Continental Championship events may be received up until the deadline for international BMX calendar applications. For UCI BMX Supercross World Cup events, application deadlines for 2015 events will be sent to each organizer concerned. Otherwise, a UCI Track Certificate application must accompany 2016 UCI BMX Supercross World Cup event bids.